

CORNICI

- OPTI KLIK KLAK
- ECO KLIK KLAK
- KLIK KLAK
- CORNICE SLIDE
- WINDOWS FRAME
- KLIK KLAK GLASS
- CORNICE QUADRO
- KLIK KLAK SU MISURA
- POSTER SNAP
- POSTER CLAMP
- STRECH FRAME
- CORNICI ALUFRAME
- PROFILO EXPO FRAME
- LAVAGNA PERSPEX
- LAVAGNE AUTOADESIVE E MAGNETICHE
- VELAPLEX
- MAGNETIC LIGHT BOX
- BACHECA NOTES
- BACHECA NOTES LED
- BACHECA
- BACHECA PLUS
- ECO LEDBOX
- SLIM LEDBOX
- LITE LEDBOX OUTDOOR
- MAGNETO LEDBOX
- LEDBOX A SOSPENSIONE
- CORNICE CRYSTAL A SOSPENSIONE
- CORNICE CRYSTAL DA MURO
- OMNI FRAME
- TENSO FRAME
- CORNICI A SCOMPARSA

OPTI KLIK KLAK

KLIK KLAK®

Cornice klik klak con angolo a 45°, si monta in modo intuitivo a parete grazie ai ganci di cui è dotata. Per il formato più piccolo A6 è possibile avere anche il supporto da tavolo; è disponibile con un quantitativo minimo di 10 pezzi.

Ora disponibili i fogli di ricambio antiriflesso.

Klik Klak frame with a 45° angle, is mounted in an intuitive way to the wall thanks to the hooks supplied with it. For smaller size A5 it can also have the support table; It is available with a minimum quantity of 10 pieces.

Now availables replacement anti-reflection sheets.

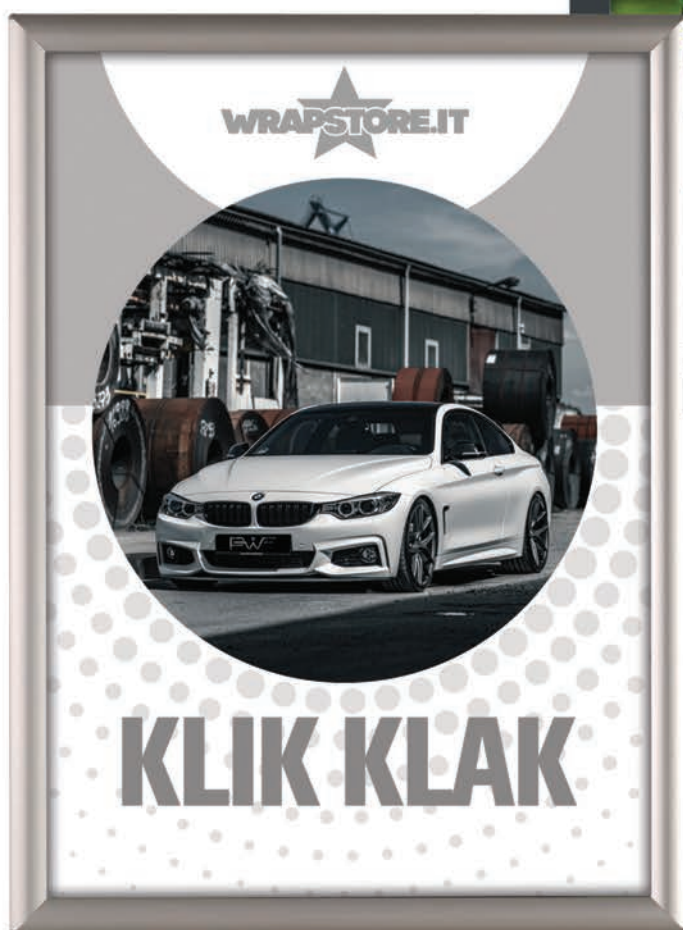

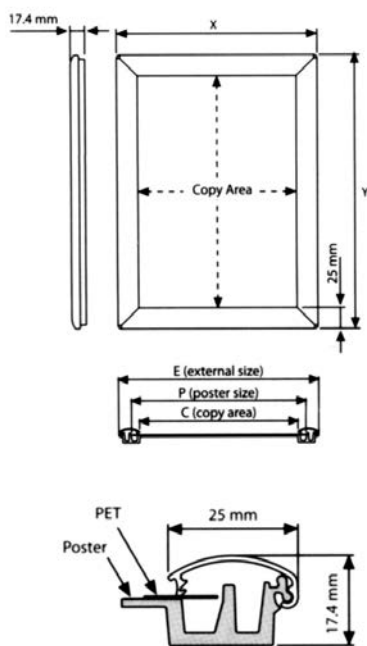
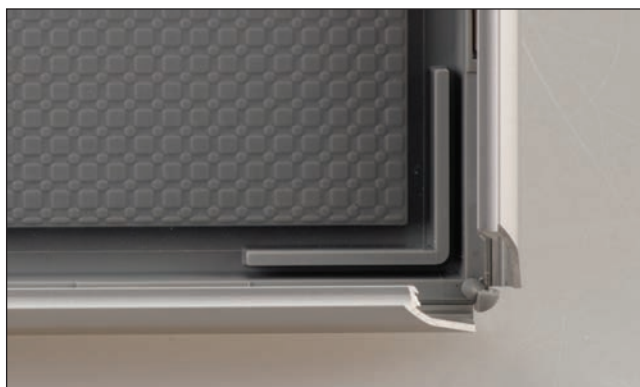
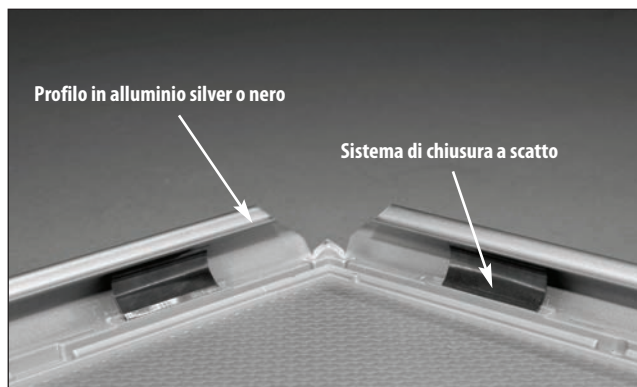

FOGLI ANTIRIFLESSO DI RICAMBIO

Codice art.	Descrizione	Formato cm.	Spess. my	L.P.
KKPVM303550	Antiriflesso 300	35x50	300	2
KKPVM305070	Antiriflesso 300	50x70	300	4
KKPVM307010	Antiriflesso 300	70x100	300	8
KKPVM501014	Antiriflesso 500	100x140	500	22

SCHEDA TECNICA

Codice art.	Colore	Dim. cm.	Dim. grafica cm.	Imballo cm.	Peso Kg.	L.P.
MTOPTSA6	Silver	12,6x16,9	10,5x14,8	13,5x18x2	0.15	8,00
MTOPTSA5	Silver	16,9x23,1	14,8x21	18x24x2	0.26	9,50
MTOPTSA4	Silver	24,1x32,8	21x29,7	25x34x2	0.50	13,00
MTOPTSA3	Silver	32,7x45	29,7x42	34x46x2	0.85	18,50
MTOPTSA2	Silver	45,0x62,4	42x59,4	47x64x2	1.23	29,00
MTOPTSB2	Silver	53x73	50x70	54,5x74x2	1.50	33,00
MTOPTYNA6	Nera	12,6x16,9	10,5x14,8	13,5x18x2	0.15	9,00
MTOPTYNA5	Nera	16,9x23,1	14,8x21	18x24x2	0.26	10,80
MTOPTYNA4	Nera	24,1x32,8	21x29,7	25x34x2	0.50	17,00
MTOPTYNA3	Nera	32,7x45	29,7x42	34x46x2	0.85	33,00
MTOPTYNA2	Nera	45x62,4	42x59,4	47x64x2	1.23	48,00
MTOPTYNB2	Nera	53x73	50x70	54,5x74x2	1.50	55,00

Cornice klik-klak con profilo da mm 25 in alluminio Silver, angolo a 45° oppure rotondo cromato; è presente il foglio in PVC antiriflesso per la protezione delle immagini. Fissaggi al muro compresi nel prezzo.

Ora disponibili i fogli di ricambio antiriflesso.

Klik - Klak frame with profile of 25 mm aluminum Silver, 45° angle or round chromed; It is included the antireflection PVC sheet for image protection. Fixing to the wall included within the price.

Now availables replacement anti-reflection sheets.

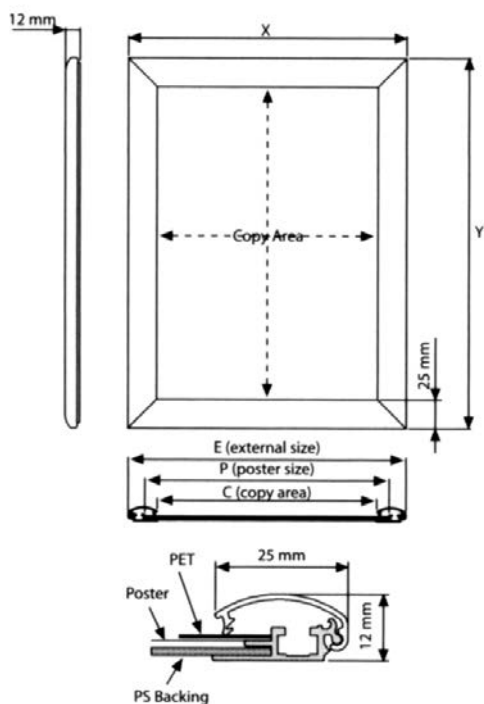

ANGOLO TONDO CROMATO



ANGOLO A 45°



FOGLI ANTIRIFLESSO DI RICAMBIO

Codice art.	Descrizione	Formato cm.	Spess. my	L.P.
KKPVM303550	Antiriflesso 300	35x50	300	2
KKPVM305070	Antiriflesso 300	50x70	300	4
KKPVM307010	Antiriflesso 300	70x100	300	8
KKPVM501014	Antiriflesso 500	100x140	500	22

SCHEDA TECNICA

Codice art.	Colore	Dim. cm.	Poster cm.	Angolo	Peso Kg.	L.P.
MTECOKKSB245	Silver	53x73	50x70	45°	1.65	40
MTECOKKSB145	Silver	73x103	70x100	45°	2.9	66
MTECOKKSB045	Silver	103x143	100x140	45°	6	108
MTECOKKSB2AT	Silver	53x73	50x70	Tondo	1.65	40
MTECOKKSB1AT	Silver	73x103	70x100	Tondo	2.9	66
MTECOKKSB0AT	Silver	103x143	100x140	Tondo	6	108

ECO KLIK KLAK

NERO - CROMO - ACCIAIO

KLIK KLAK®

Cornice klik-klak con profilo da 25 mm. in alluminio disponibile in diverse colorazioni, angolo a 45°; è presente il foglio in PVC antiriflesso per la protezione delle immagini. Fissaggi al muro compresi nel prezzo. Ora disponibili i fogli di ricambio antiriflesso.

Klik Klak frame with profile from mm. 25, aluminum available in different colors, 45° angle; it is included the antireflection PVC sheet for image protection. Fixing to the wall included within the price. Now availables replacement anti-reflection sheets.

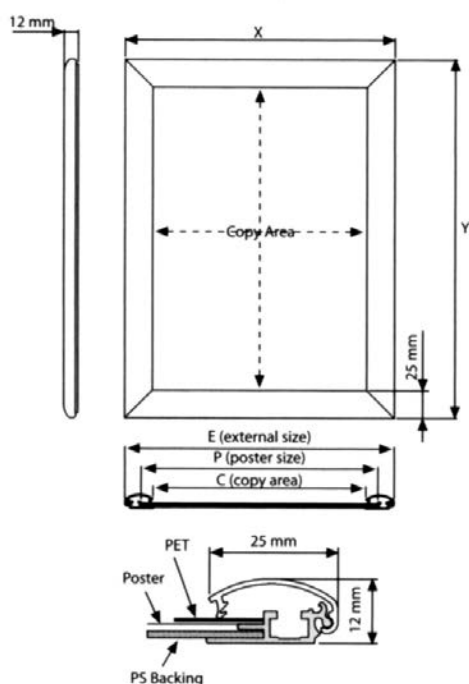

FOGLI ANTIRIFLESSO DI RICAMBIO

Codice art.	Descrizione	Formato cm.	Spess. my	L.P.
KKPVM303550	Antiriflesso 300	35x50	300	2
KKPVM305070	Antiriflesso 300	50x70	300	4
KKPVM307010	Antiriflesso 300	70x100	300	8
KKPVM501014	Antiriflesso 500	100x140	500	22

SCHEDA TECNICA

Codice art.	Colore	Dim. cm.	Poster cm.	Angolo	Peso Kg.	L.P.
MTECOKKCB245	Cromo	53x73	50x70	45°	1.6	78
MTECOKKCB145	Cromo	73x103	70x100	45°	2.3	126
MTECOKKCB045	Cromo	103x143	100x140	45°	6	198
MTECOKKNB245	Nero	53x73	50x70	45°	1.6	55
MTECOKKNB145	Nero	73x103	70x100	45°	2.3	77
MTECOKKNB045	Nero	103x143	100x140	45°	6	122
MTECOKKAB245	Acciaio	53x73	50x70	45°	1.6	56
MTECOKKAB145	Acciaio	73x103	70x100	45°	2.3	88
MTECOKKAB045	Acciaio	103x143	100x140	45°	6	140

ECO KLIK KLAK

ANTI EFFRAZIONE

Speciale cornice klik klak con profilo di sicurezza da mm. 25, angolo a 45°, sbloccabile soltanto con apposita chiave, fornita in dotazione. Ora disponibili i fogli di ricambio antiriflesso.

Special frame klik klak with safety profile from mm. 25, 45° angle, unlockable only by special tool, provided. Now availables replacement anti-reflection sheets.

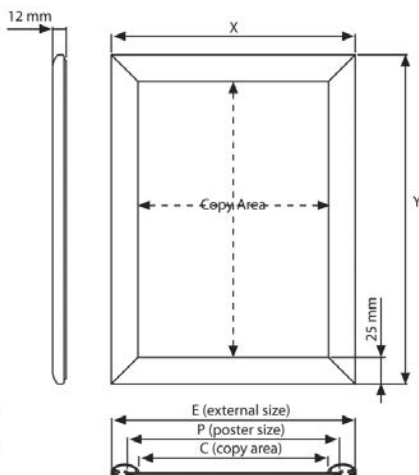
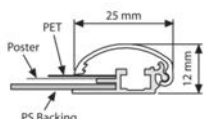

FOGLI ANTIRIFLESSO DI RICAMBIO

Codice art.	Descrizione	Formato cm.	Spess. my	L.P.
KKPVM303550	Antiriflesso 300	35x50	300	2
KKPVM305070	Antiriflesso 300	50x70	300	4
KKPVM307010	Antiriflesso 300	70x100	300	8
KKPVM501014	Antiriflesso 500	100x140	500	22

SCHEDA TECNICA

Codice art.	Colore	Dim. cm.	Poster cm.	Angolo	Peso Kg.	L.P.
MTSECKKSB245	Silver	53x73	50x70	45°	2.45	58
MTSECKKSB145	Silver	73x103	70x100	45°	4.33	88
MTSECKKSB045	Silver	103x143	100x140	45°	5.55	146
MTUTE	Utensile per apertura cornici					3

KLIAKLAK®



ECO KLIK KLAK

WATERPROOF

Cornice klik klak con profilo in alluminio da mm. 25, resistente alle intemperie e con fori di drenaggio per l'acqua; Ora disponibili i fogli di ricambio antiriflesso.

Klik Klak frame with aluminum mm. 25, weather resistant and with drainage holes for water; Now availables replacement anti-reflection sheets.

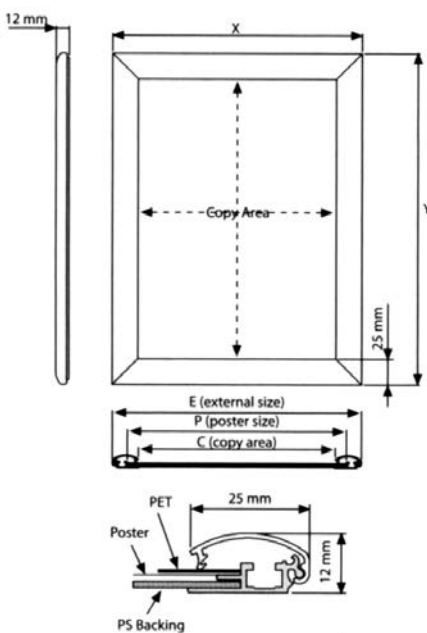

FOGLI ANTIRIFLESSO DI RICAMBIO

Codice art.	Descrizione	Formato cm.	Spess. my	L.P.
KKPVM303550	Antiriflesso 300	35x50	300	2
KKPVM305070	Antiriflesso 300	50x70	300	4
KKPVM307010	Antiriflesso 300	70x100	300	8
KKPVM501014	Antiriflesso 500	100x140	500	22

SCHEDA TECNICA

Codice art.	Colore	Dim. cm.	Grafica cm.	Peso Kg.	L.P.
MTWPKKSB245	Silver	55x75	50x70	2.1	70
MTWPKKSB145	Silver	75x105	70x100	3.9	105
MTWPKKSB045	Silver	105x145	100x140	6.05	174

Cornice klik klak in alluminio anodizzato, colore silver, con fondale in plastica antigraffio e protezione antiriflesso sul fronte. Ora disponibili i fogli di ricambio antiriflesso.

Klik Klak frame in anodized aluminum, silver color, with bottom in plastic anti-scratch and anti-glare protection on the front. Now available replacement anti-reflection sheets.

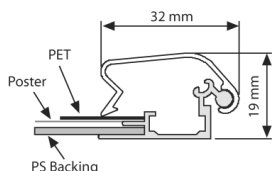

SCHEMA TECNICA

Codice art.	Formato cm.	L.P.
DSKKA4	21x30	54
DSKKA3	42x30	70
DSKK3550	35x50	78
DSKKB2	50x70	108
DSKKB1	70x100	148
DSKKB0	100x140	224

FOGLI ANTIRIFLESSO DI RICAMBIO

Codice art.	Descrizione	Formato cm.	Spess. my	L.P.
KKPVM303550	Antiriflesso 300	35x50	300	2
KKPVM305070	Antiriflesso 300	50x70	300	4
KKPVM307010	Antiriflesso 300	70x100	300	8
KKPVM501014	Antiriflesso 500	100x140	500	22



CORNICE SLIDE

Cornice bifacciale in alluminio anodizzato Silver, con film protettivo antiriflesso; incluso il biadesivo posto sulla base. Utilizzabile anche per segnaletica bifacciale da interni.

Ora disponibili i fogli di ricambio antiriflesso.

Double-Sided silver anodized aluminum frame, with anti-glare protective film; including double-sided tape on the base. It can also be used for double-sided signs interior. Now available replacement anti-reflection sheets.



FOGLI ANTIRIFLESSO DI RICAMBIO

Codice art.	Descrizione	Formato cm.	Spess. my	L.P.
KKPVM303550	Antiriflesso 300	35x50	300	2
KKPVM305070	Antiriflesso 300	50x70	300	4
KKPVM307010	Antiriflesso 300	70x100	300	8
KKPVM501014	Antiriflesso 500	100x140	500	22

SCHEMA TECNICA

Codice art.	Dim. cm.	Poster cm.	Peso Kg.	Imballo cm.	L.P.
MTCOSLA4	31x23	29.7x21	0.9	26x36x7	34
MTCOSLA3	43x31	42x29.7	1.2	34x47x7	45

WINDOWS FRAME

Cornice in materiale plastico per messaggi bifacciali da apporre su vetro; compreso nel kit il biadesivo di fissaggio e la finta cornice da fissare posteriormente. Disponibile nei colori B (nero) e G (grigio).

Plastic frame for double sided messages to be affixed on the glass; included in the kit the double-sided tape for fixing and the false frame to be fixed at the back. Available in B (black) and G (grey) colours.

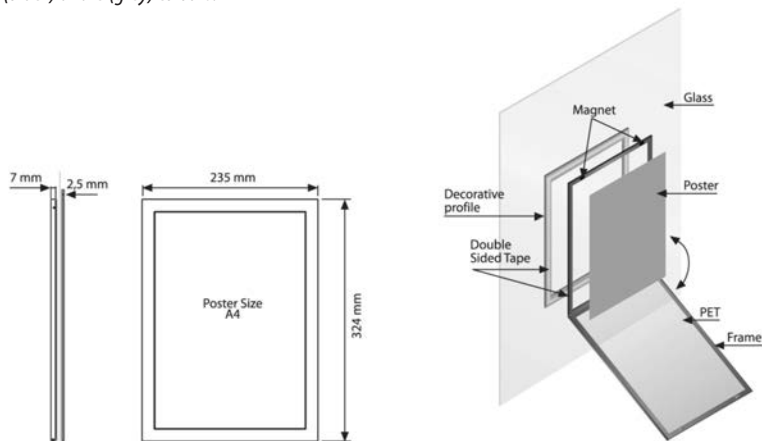

SCHEDA TECNICA

Codice art.	Colore	Dim. cm.	Poster cm.	Peso Kg.	Imballo cm.	L.P.
MTWIFRA4N	Nero	23,5x32,4	21x29,7	0,35	25x35x2	16
MTWIFRA4G	Grigio	23,5x32,4	21x29,7	0,35	25x35x2	16

KLICK KLAK GLASS

Cornice Klick Klak in alluminio Silver di spessore mm. 25, per l'esposizione e la sostituzione rapida di manifesti su vetri, visibili sia da lato interno che da quello esterno grazie al profilo che simula la cornice posteriore. Pellicola antiriflesso e biadesivo inclusi nella confezione. Ora disponibili i fogli di ricambio antiriflesso.

Klick Klak Aluminium Silver frame mm thick. 25, for the display and the quick replacement of posters on glasses, visible both from the inside and from outside thanks to the profile that simulates the rear frame. Double-sided anti-reflection film included.

Now availables replacement anti-reflection sheets.

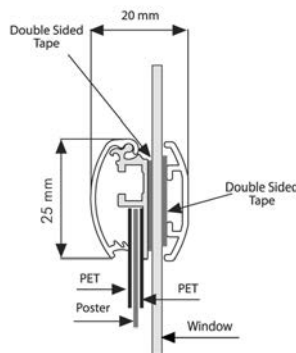

KLICK KLAK®

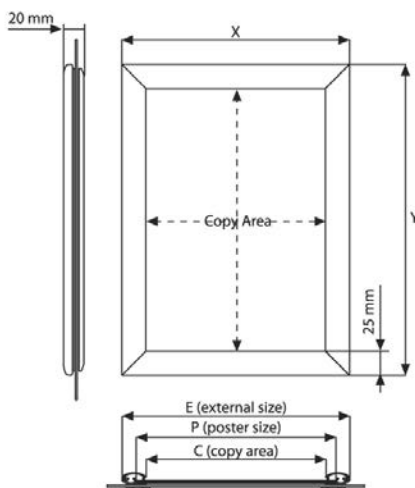

FOGLI ANTIRIFLESSO DI RICAMBIO

Codice art.	Descrizione	Formato cm.	Spess. my	L.P.
KKPVM303550	Antiriflesso 300	35x50	300	2
KKPVM305070	Antiriflesso 300	50x70	300	4
KKPVM307010	Antiriflesso 300	70x100	300	8
KKPVM501014	Antiriflesso 500	100x140	500	22

SCHEDA TECNICA

Codice art.	Colore	Dim. cm.	Poster cm.	Peso Kg.	Imballo cm.	L.P.
MTKKGLAA4	Silver	24x33	21x29.7	0.6	26x35x2	32
MTKKGLAA3	Silver	33x45	29,7x42	0.9	35x46x2	40
MTKKGLAA2	Silver	45x63	42x59,4	1.1	46x66x2	54
MTKKGLAA1	Silver	63x87	59,4x84,1	2.1	65x90x2	76
MTKKGLAB2	Silver	53x73	50x70	1.4	55x75x2	64
MTKKGLAB1	Silver	73x103	70x100	2.7	75x105x2	90

Cornice a scatto colore silver dal design moderno con angoli a 45°, grazie al profilo doppio da 37 mm è possibile fissarne una accanto all'altra senza lasciare spazi e sostituire la grafica senza problemi. Disponibili i fogli di ricambio antiriflesso.

Snap frame in silver color with a modern design with 45° square corners, thanks to the double profile thickness 37 mm it is possible to fix one next to the other without leaving spaces and replace the graphics without problems. Anti-reflective spare sheets available.



SCHEDA TECNICA

Codice art.	Formato cm.	L.P.
JDKKQUA4	A4 (21x29,7)	44
JDKKQUA3	A3 (29,7x42)	58
JDKKQUA2	A2 (42x59,4)	74
JDKKQUA1	A1 (59,4x84,1)	104
JDKKQUB2	50x70	102
JDKKQUB1	70x100	130
JDKKQUB0	100x140	220

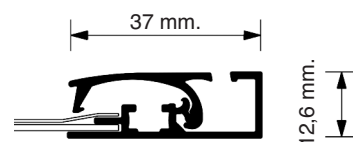

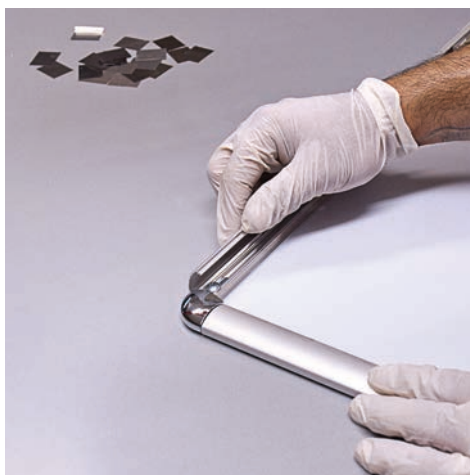
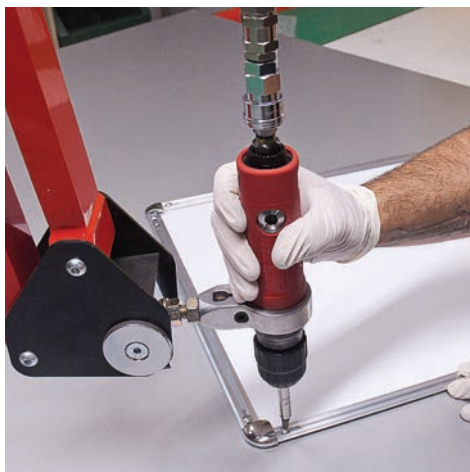

REALIZZIAMO A RICHIESTA CORNICI KLIK KLAK SU MISURA: È SUFFICIENTE SAPERE LA QUANTITÀ DESIDERATA ED IL FORMATO, SIA DI INGOMBRO ESTERNO CHE DEL POSTER INTERNO E, IN MENO DI 24 ORE, IL VOSTRO PREVENTIVO PERSONALIZZATO SARÀ PRONTO. È POSSIBILE SCEGLIERE TRA 2 TIPOLOGIE E DI PROFILO DIVERSE: **IL PRIMO INDICATO FOTO A**, È DI SPESSORE mm 25 (È LO STESSO DELLA CORNICE ECO KLIK KLAK), MENTRE **IL SECONDO, INDICATO IN FOTO B**, È DI SPESSORE mm 32; CON ENTRAMBI I PROFILI È POSSIBILE AVERE L'ANGOLO TONDO CROMATO.

MODELLO A

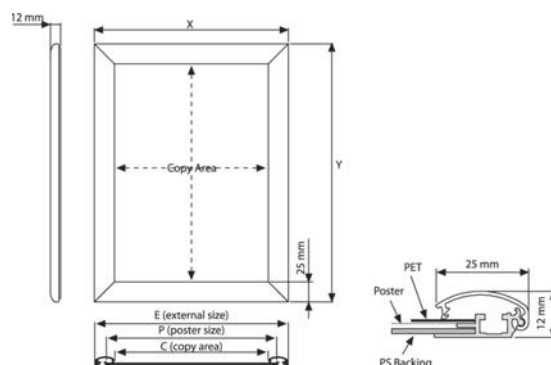

MODELLO B

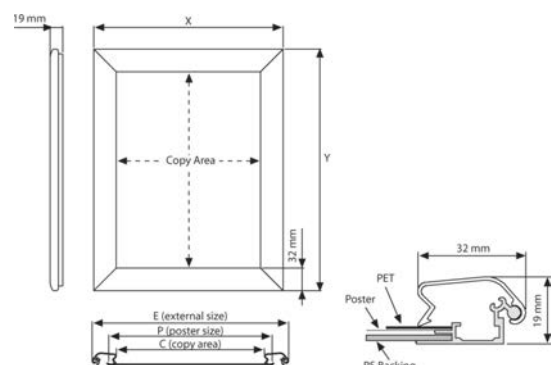

POSTER SNAP

Profili tendi-poster in alluminio anodizzato Silver, spessore mm. 26, con chiusura a pressione ed agganci per il fissaggio a muro. Nel set sono inclusi il profilo superiore ed inferiore.

Silver anodized aluminum posters snap, thickness mm. 26, with closure pressure and hooks for wall fixing. In the set are included profile top and bottom.

SCHEMA TECNICA

Codice art.	Descrizione	Poster cm.	L.P.
MTPOSNA50	Coppia barre cm. 50	50	17
MTPOSNA60	Coppia barre cm. 60	60	20
MTPOSNA70	Coppia barre cm. 70	70	22
MTPOSNA85	Coppia barre cm. 85	85	24
MTPOSNA100	Coppia barre cm. 100	100	29



POSTER CLAMP

Coppia di barre in alluminio anodizzato Silver, spessore mm. 25, adatte per l'affissione di poster da soffitto grazie ai ganci superiori. Il poster è fissato tramite chiusura a pinza.

Pair of anodized aluminum bars Silver, thickness mm. 25, suitable for the display of posters from the ceiling due to the upper hooks. The poster is fixed by pincers latch.

SCHEMA TECNICA

Codice art.	Descrizione	Poster cm.	L.P.
MTPOCLA50	Coppia barre cm. 50	50	21
MTPOCLA60	Coppia barre cm. 60	60	24
MTPOCLA70	Coppia barre cm. 70	70	27
MTPOCLA85	Coppia barre cm. 85	85	31
MTPOCLA100	Coppia barre cm. 100	100	36

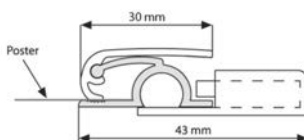

STRECH FRAME

Pratica cornice in alluminio anodizzato Silver e angolari in plastica nera, con molle per tendere la grafica centrale tramite graffette, che consentono anche un veloce cambio immagine. Dotata di ganci, può essere sia appesa al soffitto che fissata al muro, ed è disponibile in diversi formati a scelta.

Practical anodized aluminum Silver frame and black plastic corners with springs to stretch the graphic panel via staples, which also allow a quick change picture. Equipped with hooks, it can be either suspended from the ceiling and mounted on the wall, and is available in several formats to choose from.

SCHEMA TECNICA

Codice art.	Misure telaio cm.	Poster cm.	L.P.
MTSTFRA4	31x39,7	21x29,7	11
MTSTFRA3	39,7x52	29,7x42	13
MTSTFRA2	52x69,4	52x69,4	15
MTSTFRA1	69,4x94,1	69,4x94,1	19
MTSTFRB2	60x80	50x70	17
MTSTFRB1	80x110	70x100	21



CORNICI ALUFRAME

Cornice in alluminio con angoli a 45° tagliata a misura, per pannelli rigidi dai mm. 2 ai mm. 10 di spessore; nel kit di montaggio sono comprese le squadrette con fissaggio a vite, gli appendini e le molle di compensazione. Disponibile anche con pannello in lavagna nera o bianca ri-scrivibile con pennarelli a gesso liquido base acqua in vari colori, resistenti alla pioggia; per la pulizia è sufficiente utilizzare un panno umido.

N.B. : PER FACILITARE LE OPERAZIONI DI MONTAGGIO LE CORNICI VENGONO FORNITE SMONTATE IN KIT. PANNELLI INCLUSI SOLO PER LA VERSIONE LAVAGNA.

Aluminum frame with 45° corners cut to size, for rigid panels from 2 mm to mm. 10 thick; in the assembly kit are included the brackets with screw, coat hangers and compensation springs. Available also with blackboard front panel black or white re-writable with chalk markers in different colours, water-resistant; to wipe off can be used a damp cloth.

N.B.: TO FACILITATE THE SETTING UP THE FRAMES ARE SUPPLIED DISASSEMBLED IN KIT. PANELS INCLUDED FOR BLACKBOARD VERSION ONLY.

SCHEDA TECNICA

Codice art.	Colore	Dim. cm.	Poster cm.	L.P.
EUALUFRAR2130	Silver	22,4x31,4	21x30	39
EUALUFRAR3040	Silver	31,4x41,4	30x40	43
EUALUFRAR3550	Silver	36,4x51,4	35x50	46
EUALUFRAR5050	Silver	51,4x51,4	50x50	47
EUALUFRAR5070	Silver	51,4x71,4	50x70	51
EUALUFRAR710	Silver	71,4x101,4	70x100	56
EUALUFRAR1010	Silver	101,4x101,4	100x100	59
EUALUFRAR1014	Silver	101,4x141,4	100x140	78

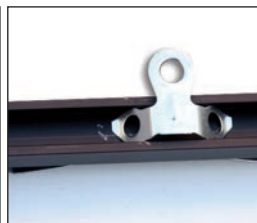
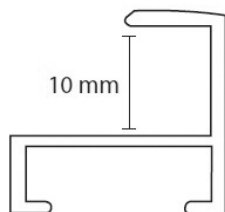
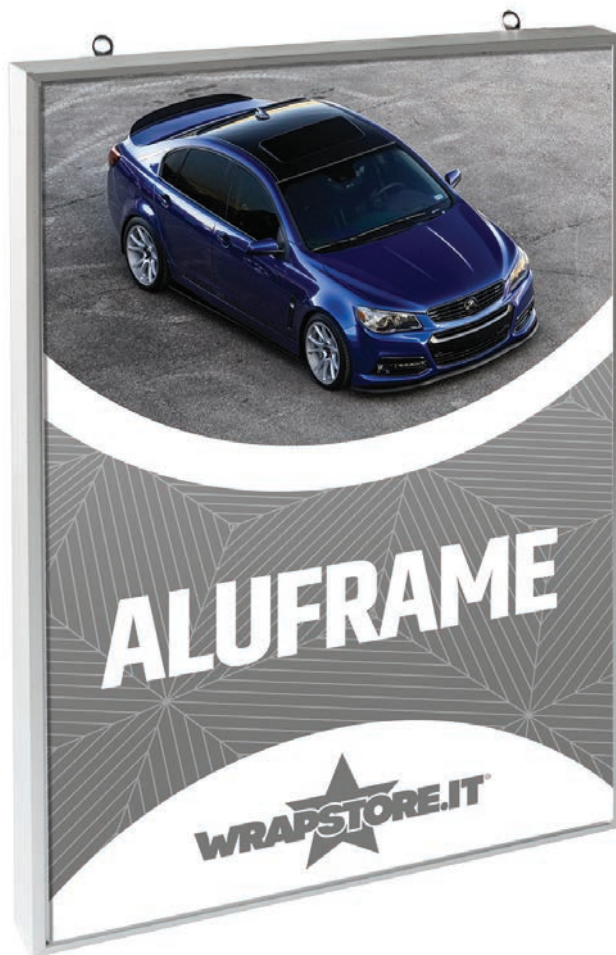

LAVAGNA BIANCA

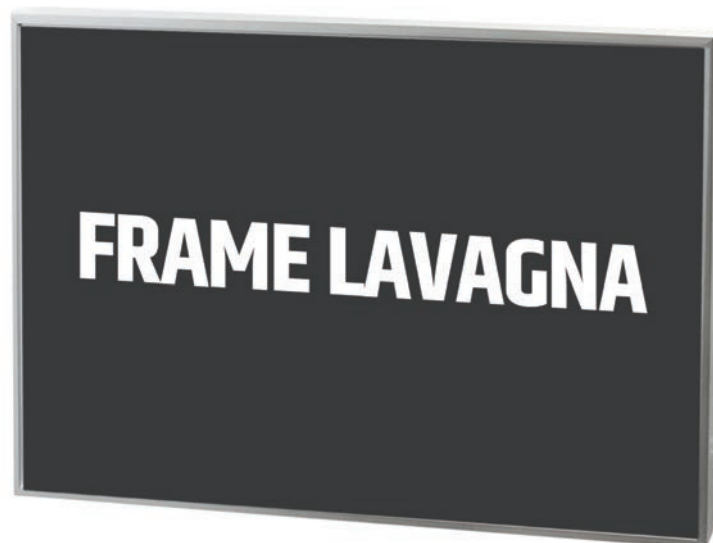

LAVAGNA NERA

SCHEDA TECNICA

Codice art.	Descrizione	L.P.
EUFRAMELAVA4	Frame Lavagna cm. 21x30	82
EUFRAMELAVA3	Frame Lavagna cm. 30x40	94
EUFRAMELAV3550	Frame Lavagna cm. 35x50	105
EUFRAMELAV5070	Frame Lavagna cm. 50x70	103
EUFRAMELAV710	Frame Lavagna cm. 70x100	134
EUFRAMELAV1014	Frame Lavagna cm. 100x140	257
IS97010	Pennarello bianco cancellabile, punta mm. 2	10
IS97011	Pennarello nero cancellabile, punta mm. 2	5

**NOSTRA PRODUZIONE
ALTRE VARIANTI E MISURE SU RICHIESTA**

VELAPLEX

Tasca porta messaggi realizzata in Perspex trasparente, disponibile sia per fissaggio a parete con biadesivo, sia per fissaggio a sospensione con pinze e tiranti. È disponibile sia verticale che orizzontale.

Pocket messages made of transparent Perspex, available for wall fixing with double-sided tape, both for suspended with clamps and rods. It is available in both vertical and horizontal.

SCHEDA TECNICA VELA SEMPLICE DA PARETE

Codice art.	Formato tasca	L.P.
EUVELSEA5	A5 verticale	10
EUVELSEA4	A4 verticale	13
EUVELSEA3	A3 verticale	26
EUVELSE57	B2 50x70 verticale	72
EUVELSE710	B1 70x100 verticale	106
EUVELSEA2	A2 42x59,4 verticale	62
EUVELSEA1	A1 59,4x84,1 verticale	112
EUVELSEA0	A0 84,1x118,9 verticale	280
EUVELSEA5HO	A5 orizzontale	11
EUVELSEA4HO	A4 orizzontale	14
EUVELSEA3HO	A3 orizzontale	26
EUVELSE57HO	B2 50x70 orizzontale	72
EUVELSE710HO	B1 70x100 orizzontale	200
EUVELSEA2HO	A2 59,4x42 orizzontale	68
EUVELSEA1HO	A1 84,1x59,4 orizzontale	140
EUVELSEA0HO	A0 118,9x84,1 orizzontale	280

SCHEDA TECNICA VELA SAGOMATA A SOSPENSIONE

Codice art.	Formato tasca	L.P.
EUVESAA5	A5 verticale	15
EUVESAA4	A4 verticale	18
EUVESAA3	A3 verticale	35
EUVESA57	B2 50x70 verticale	100
EUVESAA710	B1 70x100 verticale	145
EUVESAA2	A2 42x59,4 verticale	75
EUVESAA1	A1 59,4x84,1 verticale	125
EUVESAA0	A0 84,1x118,9 verticale	280
EUVESAA5HO	A5 orizzontale	15
EUVESAA4HO	A4 orizzontale	18
EUVESAA3HO	A3 orizzontale	35
EUVESA57HO	B2 50x70 orizzontale	90
EUVESA710HO	B1 70x100 orizzontale	280
EUVESAA2HO	A2 59,4x42 orizzontale	75
EUVESAA1HO	A1 84,1x59,4 orizzontale	144
EUVESAA0HO	A0 118,9x84,1 orizzontale	280

SCHEDA TECNICA VELA SEMPLICE CON TESTATA E FORI

Codice art.	Formato tasca	L.P.
EUVELSEA5TF	A5 verticale	13
EUVELSEA4TF	A4 verticale	15
EUVELSEA3TF	A3 verticale	28
EUVELSE57TF	B2 50x70 verticale	75
EUVELSE710TF	B1 70x100 verticale	112
EUVELSEA5HOTF	A5 orizzontale	13
EUVELSEA4HOTF	A4 orizzontale	16
EUVELSEA3HOTF	A3 orizzontale	28
EUVELSE57HOTF	B2 50x70 orizzontale	75



VELA SEMPLICE



VELA SAGOMATA



VELA SEMPLICE CON TESTATA E FORI

NOSTRA PRODUZIONE
ALTRE VARIANTI E MISURE SU RICHIESTA

MAGNETIC LIGHT BOX

Soluzione espositiva per valorizzare messaggi rivolti al pubblico, composta da tasca trasparente in Perspex con integrati serie di LED; grazie allo speciale pannello acrilico, la luminosità è intensa e omogenea e risalta la grafica esposta. La tasca è fissata mediante cavi di acciaio e fissaggi a soffitto; gli stessi hanno anche la funzione di cablaggio elettrico in bassa tensione a 24 Volt. Le tasche sono disponibili nei formati A4 e A3 nella versione monofacciale sia orizzontale che verticale.

Expositive solution to valorize messages to the public, consisting of a transparent Perspex pocket with LED in it; thanks to the special acrylic panel, the brightness is intense and homogeneous and gives valor to the exposed graphic. The pocket is fixed through steel wires and ceiling fissings, which also have the function of electric wiring in 24 Volt low tension. Pockets are available in A4 and A3 monofacial format, both horizontal and vertical.



LED PANEL VERTICALE



LED PANEL ORIZZONTALE

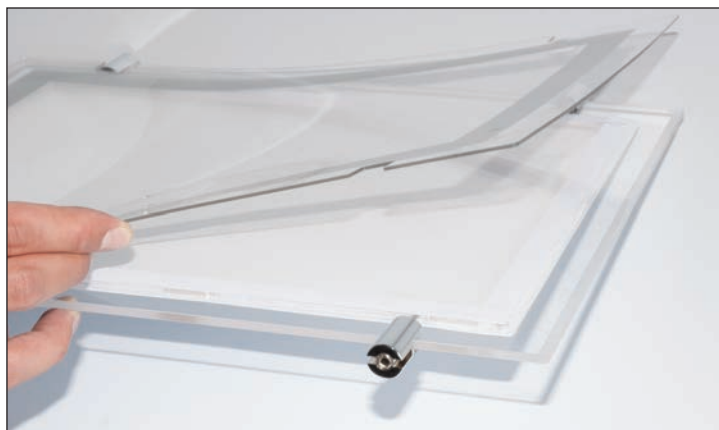

SCHEDA TECNICA

Codice art.	Descrizione	Dim. cornice mm.	Dim. grafica mm.	Spess. cornice mm.	Volt	Potenza Watt	L.P.
UFLBBA4P	Led Pannel f.to A4 verticale	363x276	297x210	8	24	4	214
UFLBBA4L	Led Pannel f.to A4 orizzontale	363x276	297x210	8	24	4	214
UFLBBA3P	Led Pannel f.to A3 verticale	486x363	420x297	8	24	4	302
UFLBBA3L	Led Pannel f.to A3 orizzontale	486x363	420x297	8	24	4	302
ET451524	Alimentatore Wall Mount 24V 15W 0,63A				24	15	56
ET454024	Alimentatore Desktop 24V 40W 1,67A				24	40	67
ET459024	Alimentatore Desktop 24V 80W 3,75A				24	80	130
UF2M	Cavo alimentazione con spinotto						7
UFBF015S	Kit sosp. Attacchi cielo/terra + cavo acciaio + isolanti						34
UFCF08	Connettore alimentazione						5,40
ETSPINA	Spina per alimentatore desktop						18

MAGNETIC LIGHT BOX

FIAP
FEDERAZIONE ITALIANA
AGENTI IMMOBILIARI
PROFESSIONALI

G

APPIO CLAUDIO: Viale Appio Claudio, a pochi passi dal Parco degli Acquadotti, dai servizi della Via Tuscolana, sito al piano terra in palazzo signorile trilocale composto da: soggiorno, cucina-tinello dal quale si accede al giardino di 120 mq, 2 camere matrimoniali doppi servizi e terrazzo di 50 mq.

Rif. 30/17 **Si Valutano Permute** Richiesta € 559.000,00 www.housedream.it





MAGNETIC LIGHT BOX

ISTRUZIONI DI MONTAGGIO



LED PANEL A4 VERTICALE



LED PANEL A4 ORIZZONTALE



LED PANEL A3 VERTICALE



LED PANEL A3 ORIZZONTALE



KIT SOSPENSIONE ATTACCHI CIELO/TERRA+CAVI ACCIAIO+ISOLANTI



ALIMENTATORE WALLMOUNT
24V - 15W - 1,25A



CAVO ALIMENTAZIONE
CON SPINOTTO



CONNETTORE
ALIMENTAZIONE



ALIMENTATORE DESKTOP 24V - 40W - 3,34A



ALIMENTATORE DESKTOP 24V - 80W - 6,67A

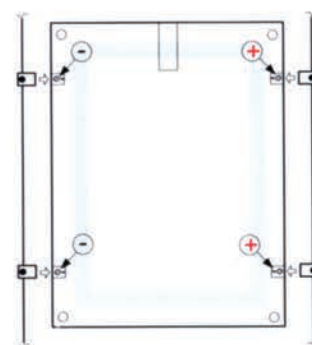
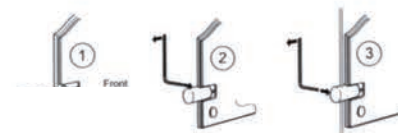

Conessioni elettriche

Attenzione:
rispettare le polarità delle tasche
come indicato in figura

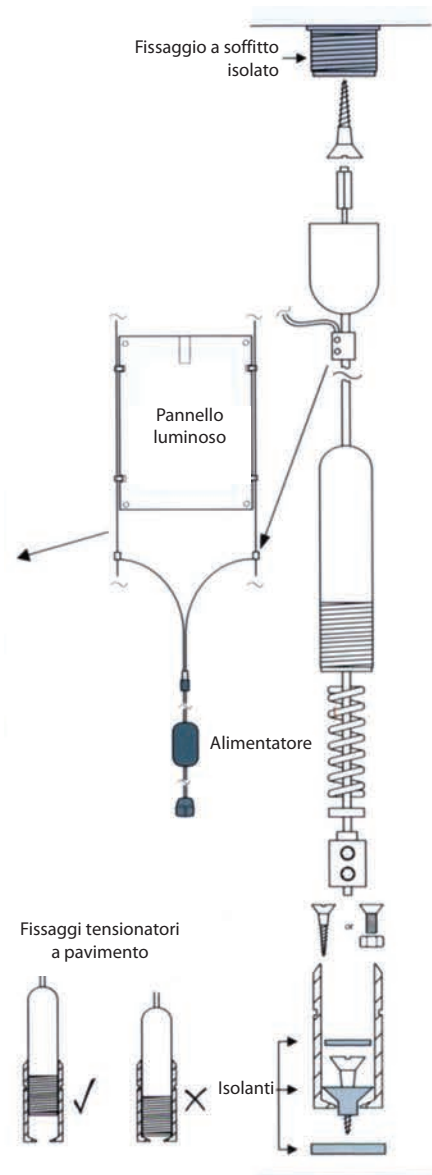

ECO LED BOX

Cornice luminosa a Led, realizzata in alluminio silver con profili da mm.25 ad apertura facilitata klik-klak, per un cambio grafica facile e veloce. Versione economica, è disponibile monofacciale nei vari formati. L'illuminazione perimetrale a Led, diffonde uniformemente la luce sulla superficie, dando gran risalto alle immagini esposte. Alimentatore Mean Well, completa questo articolo.

LED frame realized with aluminum profiles thickness mm. 25 and klik-klak opening, for an easy and fast graphic replacement. Cheap version, is available monofacial in several sizes. The perimetric LED lighting diffuses evenly the bright on the surface, giving a great prominence to the graphics. Mean-Well power-supply included.

LED TECHNOLOGY



ALIMENTATORE MEAN WELL

SCHEDA TECNICA

Cod. articolo	Dimen. poster cm.	Dimen. esterne cm.	Dimen. visualiz. cm.	L.P.
CEECOLBOXA4	21x29,7	24,2x32,9	19x27,7	150
CEECOLBOXA3	29,7x42	32,9x45,2	27,7x40	198
CEECOLBOXB3	35x50	38,2x53,2	33x48	221
CEECOLBOXB2	50x70	53,2x73,2	48x68	285
CEECOLBOXB1	70x100	73,2x103,2	68x98	438

SLIM LED BOX

Cornice luminosa a Led, ultrasottile, realizzata in alluminio silver con profili ad apertura facilitata klik-klak, per un cambio grafica facile e veloce. Design pulito e lineare, questo prodotto è disponibile in vari formati nelle versioni monofacciali e bifacciale a sospensione. L'illuminazione perimetrale a Led, diffonde uniformemente la luce sulla superficie, dando gran risalto alle immagini esposte. Alimentatore Mean Well, completa questo articolo.

Super-thin LED frame, realized with klik-klak silver aluminum profiles, for a fast and easy graphic replacement. With a linear and clean design, this product is available in several sizes both monofacial and bifacial for suspension mounting. The perimetric LED lighting diffuses the bright evenly on the surface, giving a great prominence to the graphics. 12V Mean-Well power-supply included.



SCHEDA TECNICA SLIM LEDBOX MONOFACCIALE

Codice art.	Dimen. poster cm.	Dimen. esterne cm.	Dimen. visualiz. cm.	L.P.
CESLLBOXA4	21x29,7	23,5x32,2	17,6x26,3	150
CESLLBOXA3	29,7x42	32,2x44,5	26,3x38,6	172
CESLLBOXB3	35x50	37,5x52,5	31,6x46,6	190
CESLLBOXB2	50x70	52,5x72,5	46,6x66,6	312
CESLLBOXB1	70x100	72,5x102,5	66,6x96,6	464

LED TECHNOLOGY



BIFACCIALE



ALIMENTATORE MEAN WELL



FISSAGGI A SOSPENSIONE INCLUSI

SCHEDA TECNICA SLIM LEDBOX BIFACCIALE

Codice art.	Dimen. poster cm.	Dimen. esterne cm.	Dimen. visualiz. cm.	L.P.
CESLLBOXA4B	21x29,7	23,5x32,2	17,6x26,3	325
CESLLBOXA3B	29,7x42	32,2x44,5	26,3x38,6	365
CESLLBOXB3B	35x50	37,5x52,5	31,6x46,6	400
CESLLBOXB2B	50x70	52,5x72,5	46,6x66,6	560
CESLLBOXB1B	70x100	72,5x102,5	66,6x96,6	750

LITE LED BOX OUTDOOR

Cornice luminosa a Led, realizzata in alluminio silver con profili ad apertura facilitata klik-klak, per un cambio grafica facile e veloce. Disponibile in vari formati solo nella versione monofacciale, questo prodotto presenta gli adeguamenti necessari per la conformità IP67, come la guarnizione che trovi intorno all'alloggiamento grafica e la connessione elettrica adeguata. L'illuminazione perimetrale a Led, diffonde uniformemente la luce sulla superficie, dando gran risalto alle immagini esposte. Alimentatore Mean Well, completa questo articolo.

LED frame realized with klik-klak silver aluminum profiles for an easy and fast graphic replacement. Available in several sizes monofacial only, this product provides all the necessary adjustments for the IP67 compliance, as the gasket around the graphic placement and the appropriate electric connection. The perimetral LED lighting diffuses evenly the bright in the surface, giving a great prominence to the graphics. Mean-Well power-supply included.

LED TECHNOLOGY



ALIMENTATORE MEAN WELL

SCHEDA TECNICA

Codice art.	Dim. Poster	Dim. esterna cm.	Dim. visualizzabile cm.	Larghezza profilo mm.	L.P.
CEOUTLEBOXA4	21x29,7	26x347	17x25,7	35	288
CEOUTLEBOXA3	29,7x42	347x47	25,7x38	35	327
CEOUTLEBOXB3	35x50	40x55	31x46	35	375
CEOUTLEBOXB2	50x70	55x75	46x66	35	494
CEOUTLEBOXB1	70x100	75x105	66x96	35	680
CEOUTLEBOXB0	100x140	105x145	96x136	35	1.255
CEOUTLEBOX1020	100x200	105x205	96x196	46	1.663
CEOUTLEBOX1917	118,9x175	123,9x180	114,9x171	46	1.674

MAGNETO **LED** BOX

Cornice luminosa a Led, ultrasottile, solo 15mm. di spessore, cambio grafica facile e veloce grazie al pannello frontale magnetico; presenta un passe-partout frontale nero che esalta l'immagine esposta. Disponibile in vari formati nelle versioni monofacciali e bifacciali a sospensione. L'illuminazione perimetrale a Led, diffonde uniformemente la luce sulla superficie, dando gran risalto alle immagini esposte. Alimentatore 12 Volt Mean Well, completa questo articolo.

LED frame with super-thin profile mm. 15 thickness, easy and fast graphic replacement thanks to the magnetic front panel; it provides a front black skeleton-key which enhance the graphic. It is available in several sizes and both monofacial and bifacial for suspension mounting. The perimetric LED lighting diffuses evenly the bright on the surface, giving a great prominence to the graphics. Mean-Well 12V power-supply included.



SCHEDA TECNICA MAGNETO LEDBOX MONOFACCIALE

Codice art.	Dimen. poster cm.	Dimen. esterne cm.	Dimen. visualiz. cm.	L.P.
CEMAGA4	21x29,7	23,5x32,2	17x25,7	160
CEMAGA3	29,7x42	32,2x44,5	25,7x38	204
CEMAGB3	35x50	37,5x52,5	31x46	230
CEMAGB2	50x70	52,5x72,5	46x66	320
CEMAGB1	70x100	72,5x102,5	66x96	472



BIFACCIALE



ALIMENTATORE MEAN WELL



FISSAGGI A SOSPENSIONE INCLUSI

SCHEDA TECNICA MAGNETO LEDBOX BIFACCIALE

Codice art.	Dimen. poster cm.	Dimen. esterne cm.	Dimen. visualiz. cm.	L.P.
CEMAGBIA4	21x29,7	23,5x32,2	17x25,7	260
CEMAGBIA3	29,7x42	32,2x44,5	25,7x38	332
CEMAGBIB3	35x50	37,5x52,5	31x46	395
CEMAGBIB2	50x70	52,5x72,5	46x66	560
CEMAGBIB1	70x100	72,5x102,5	66x96	1.150

LED BOX A SOSPENSIONE

Cornice monofacciale luminosa a Led ultrasottile solo 13 mm, cambio grafica facile e veloce grazie al profilo klik klak di spessore mm. 25. Montaggio a sospensione con cavi in acciaio alimentati per illuminazione a Led propagata sulla superficie tramite incisione laser a punti per una diffusione uniforme della luce, dando gran risalto alle immagini esposte. L'alimentatore 12Volt MeanWell completa questo articolo.

Single-sided luminous frame with ultra-thin LED only 13 mm, quick and easy graphic change thanks to the klik klak profile with a thickness of mm. 25. Suspension mounting with steel cables powered by LED lighting propagated on the surface by laser dot engraving for a uniform diffusion of light, giving great prominence to the images on display. The MeanWell 12Volt power supply completes this article.

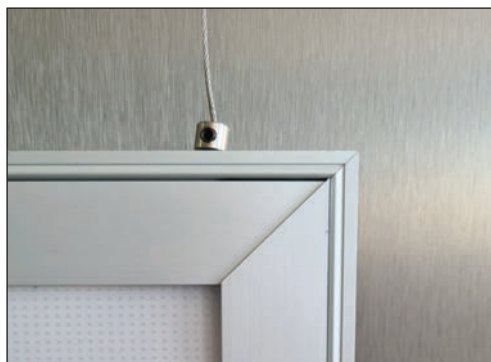

SCHEDA TECNICA

Codice art.	Dimen. poster cm.	Dimen. esterne cm.	Dimen. visualiz. cm.	L.P.
CELEDFRA5070	50x70	53x73	47x67	320
CELEDFRA70100	70x100	73x104	67x97	474
CELEDFRA100140	100x140	103x143	97x137	740

CORNICE CRYSTAL A SOSPENSIONE

Cornice luminosa a Led, ultrasottile, solo 15mm. di spessore, cambio grafica facile e veloce grazie al pannello frontale magnetico; presenta un passe-partout frontale argento che esalta l'immagine esposta. Disponibile in vari formati bifacciali a sospensione. L'illuminazione perimetrale a Led diffonde uniformemente la luce sulla superficie, dando gran risalto alle immagini esposte. L'alimentatore 12Volt MeanWell completa questo articolo.

Led light frame, ultra-thin, only 15mm. thick, quick and easy graphic change thanks to the magnetic front panel; has a silver front passe-partout that enhances the image on display. Available in various double-sided suspension formats. The perimeter LED lighting spreads the light evenly on the surface, giving great prominence to the images on display. The 12 Volt MeanWell power supply completes this article.



SCHEDA TECNICA

Codice art.	Dimen. poster cm.	Dimen. esterne cm.	Dimen. visualiz. cm.	L.P.
CECRYS5070	50x70	60,5x80,5	48,6x98,6	692
CECRYS6080	59,4x84,1	70x95,6	58x82,7	870
CECRYS70100	70x100	80,5x110,5	68,6x98,6	1.044

CORNICE CRYSTAL DA MURO

Cornice da muro luminosa a Led ultrasottile, cambio grafica facile e veloce grazie al pannello frontale magnetico; presenta un passe-partout frontale di mm. 25 argento che esalta l'immagine esposta, e 4 distanziali cromati inclusi. L'illuminazione perimetrale a Led diffonde uniformemente la luce sulla superficie, dando gran risalto alle immagini esposte. L'alimentatore 12Volt MeanWell completa questo articolo.

Ultra-thin LED light wall frame, quick and easy graphic change thanks to the magnetic front panel; has a front passe-partout of mm. 25 silver that enhances the image on display, and 4 chromed spacers included. The perimeter LED lighting spreads the light evenly on the surface, giving great prominence to the images on display. The 12Volt MeanWell power supply completes this article.



SCHEDA TECNICA

Codice art.	Dimen. poster cm.	Dimen. esterne cm.	Dimen. visualiz. cm.	L.P.
CECRYSMUA4	21x29,7	35,2x41,2	18,5x27,2	180
CECRYSMUA3	29,7x42	41,2x53,5	27,2x39,5	230
CECRYSMUA2	42x59,4	53,5x70,9	39,5x56,9	346
CECRYSMUA1	59,4x84,1	70,9x95,6	56,9x81,6	513
CECRYSMUB3	35x50	46,5x61,5	32,5x47,5	260
CECRYSMUB2	50x70	61,5x81,5	47,5x67,5	435
CECRYSMUB1	70x100	81,5x111,5	67,5x97,5	660

OMNI FRAME

Set di profili e connessioni in alluminio anodizzato silver per l'assemblaggio di strutture per il tensionamento di banner. Soluzione adatta per l'affissione a parete o per la realizzazione di cavalletti, grazie agli accessori disponibili. Questo kit consente la realizzazione di strutture senza limiti nelle dimensioni.

Silver anodized aluminum profiles and connections set for banner building and tensioning. Solution suitable for wall mounting or easels, thanks to the available accessories. This kit allows the building of no limit size structures.

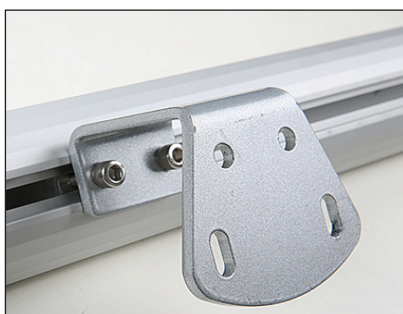

TUTTE LE MISURE SU RICHIESTA

BREVETTO DM/084 725



SCHEMA TECNICA

Codice art.	Descrizione	L.P.
MTOFPRBA310	Profilo principale in alluminio mt. 3,10	132
MTOFPRBA510	Profilo principale in alluminio mt. 5,10	214
MTOFCOANG	Conf. 4 connettori angolo	100
MTOFCOLONG	Conf. 2 connettori giunzione	46
MTOFCONT	Conf. 2 connettori "T"	66
MTOFSTAFFA	Conf. Kit 4 staffe fissaggio a parete	62
MTOFPE	Conf. 20 perni in plastica per fissaggio banner	16
MTOFPIE	Conf. 4 Kit piedi per cavalletto	110
MTOFCEERN	Conf. 2 Kit cerniera per cavalletto	72

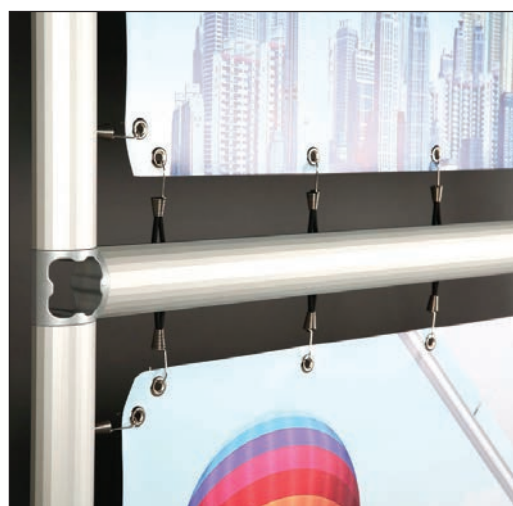

TUTTE LE MISURE SU RICHIESTA







TENSO FRAME



Soluzione per la realizzazione di cassonetti luminosi e non per esposizioni da interno e da esterno. Questa soluzione è versatile in quanto è facile da installare ed è composta da un numero di componenti estremamente ridotto. Il kit è composto dal profilo principale, gli accessori per l'angolo e la giuntura in linea ed i nottolini per il fissaggio del banner.

Solution to build lightboxes and not for indoor or outdoor exhibitions. This solution is versatile because is easy to install and composed by few elements. Kit is composed of a main profile, corner accessories, straight juncture and sliding pins for the banner fixing.

SCHEDA TECNICA

Codice art.	Descrizione	L.P.
TF PR14610	 Profilo principale in alluminio mt. 6,10	560
TF C014610	 Chiusura profilo principale in alluminio Silver da mt. 6,10	228
TF PE	 Perni scorrevoli per aggancio telo	4
TF COANG	 Angolo in alluminio	13
TF COLONG	 Inserto per giunzione profilo principale in alluminio	8,50
TF COCO	 Inserto per giunzione profilo di chiusura	1

TUTTE LE MISURE SU RICHIESTA

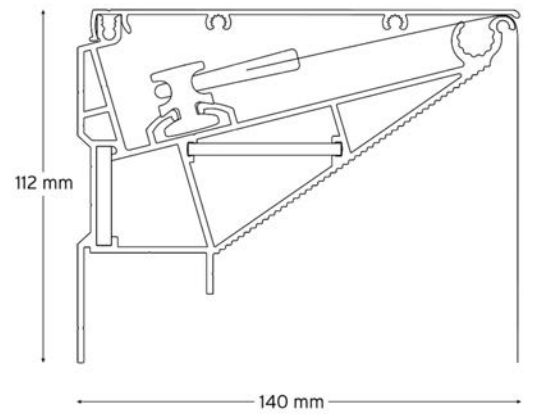

SEZIONE PROFILO PRINCIPALE



TUTTE LE MISURE SU RICHIESTA

CORNICI A SCOMPARSA

Profili in alluminio disponibili da mm. 8 o mm. 15 di spessore, lunghezza max cm. 300, finitura in argento anodizzato, con cui è possibile realizzare cornici nascoste da fissare a pannelli tramite biadesivo (incluso). La struttura portante si fissa tramite angolari in plastica ad incastro inclusi nel kit, dotati di regolazioni per un perfetto livellamento della grafica; fissaggio a muro con viti. Misure cornice su richiesta.

Aluminum profiles available from mm. 8 or mm. 15 thick, max length cm. 300, anodized silver finish, with which it is possible to create hidden frames to be fixed to panels using double-sided tape (included). The supporting structure is fixed by means of interlocking plastic corners included in the kit, equipped with adjustments for a perfect leveling of the graphics; wall fixing with screws. Frame sizes on request.

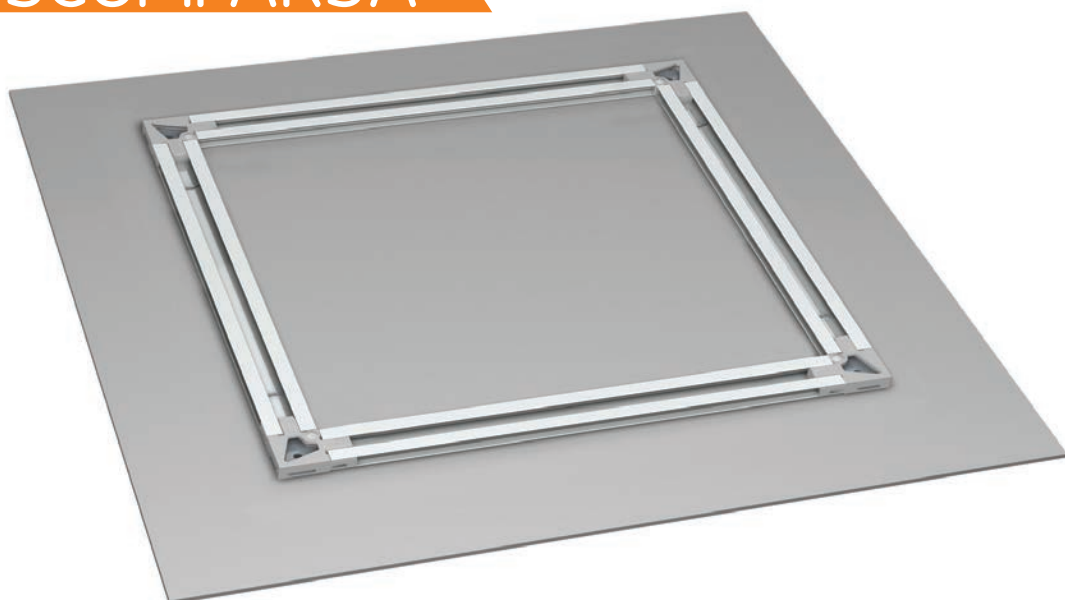

ARGENTO ANODIZZATO

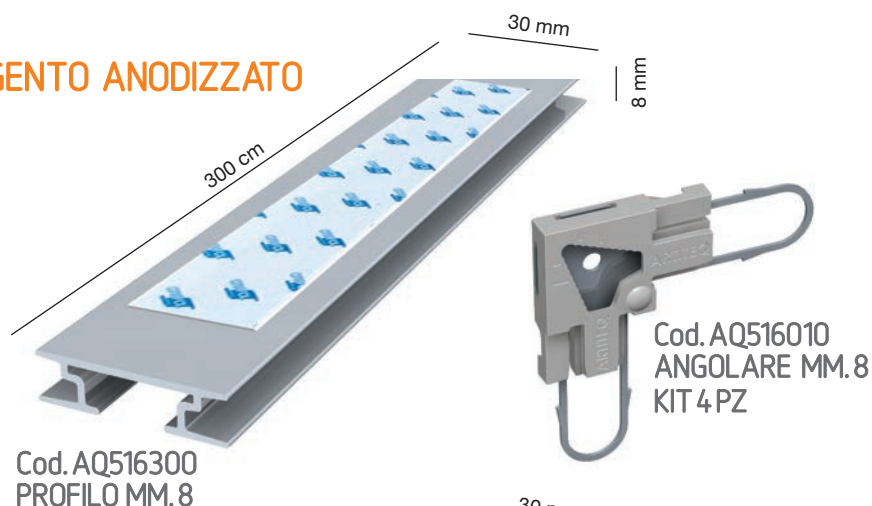

BIADESIVO
MM. 25x25MTL

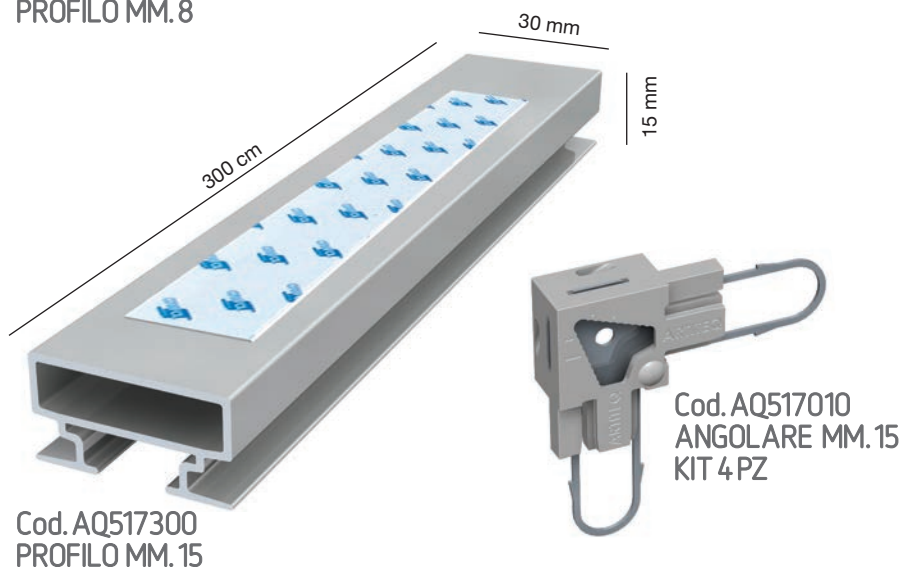

SCHEDA TECNICA PROFILI

Cod. articolo	Descrizione	Lunghezza cm.	L.P.
AQ516300	Profilo alluminio spess. mm. 8	300	63
AQ517300	Profilo alluminio spess. mm. 15	300	103

SCHEDA TECNICA ANGOLARI

Cod. articolo	Descrizione	L.P.
AQ516010	Angolare spess. mm. 8, kit 4 pz	30
AQ517010	Angolare spess. mm. 15, kit 4 pz	32

SCHEDA TECNICA BIADESIVO

Cod. articolo	Descrizione	Altezza mm.	Lunghezza cm.	L.P.
OF1812TM25	Biadesivo schiuma bianco	25	25	15,20

NOSTRA PRODUZIONE
ALTRE VARIANTI E MISURE SU RICHIESTA